

Idrabagno Lx

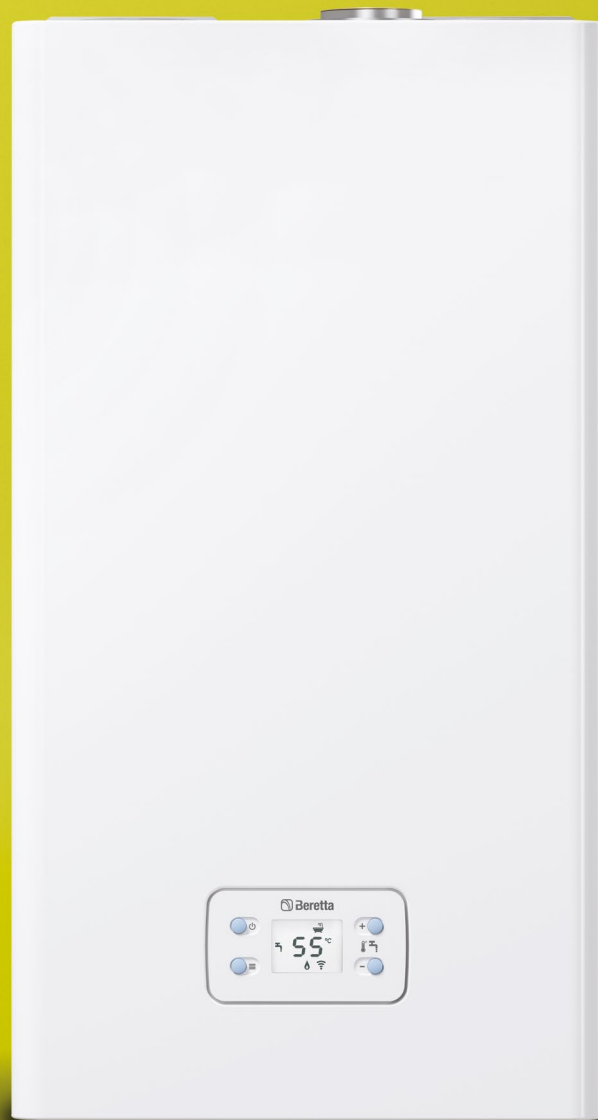

Instantaneous Gas Water Heaters,
room-sealed, low NOx



A Carrier Company

THE RANGE

Idrabagno Lx, the new low NOx water heater

IDRABAGNO Lx is the new range of low NOx, room-sealed, instantaneous water heaters, completely renewed in the design, both functionally and aesthetically. The new room-sealed water heater, fully designed and developed by Beretta, **offers the maximum domestic hot water comfort while complying with the recent European rules in terms of low NOx emissions.** The wide range of IDRABAGNO Lx, consisting of 3 models of 11, 13 and 17 litres, with specific order codes both for natural gas and LPG, thanks to the new aesthetics, **linear and elegant**, and to the **compact dimensions**, blends easily into any home setting, representing the ideal solution

to meet any domestic hot water requirements for residential use. **Designed for indoor installation, the new water heaters are allowed to be installed also outdoor, in a partially protected place, with the addition of the frost protection kit**, available as an accessory, down to a temperature of -10°C.

IDRABAGNO Lx line includes the **specific model FLEX, as 11 litres version**, available both as natural gas and LPG order code, **supplied as standard with the flexible connections and the domestic hot water tap.**

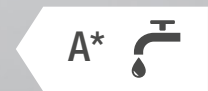

* The range of energy efficiency class of this products category is between F and A+.

INNOVATIVE ELECTRONICS AND MANAGEMENT

Many new functions, a linear and modern design

The new **IDRABAGNO Lx** are characterized by the **new electronics** which, combined with the modern and linear design, results in a new **control panel, simple and intuitive**, with many additional and innovative features. Through a **large backlit digital display** (40 x 60 mm) and **four buttons**, the user can manage all the functions of the

water heater and easily navigate the menu. **The icon language of the display** makes the general setting of the appliance and the activation of the special functions particularly intuitive, as well as immediately displaying the **diagnostics** in the event of anomalies.

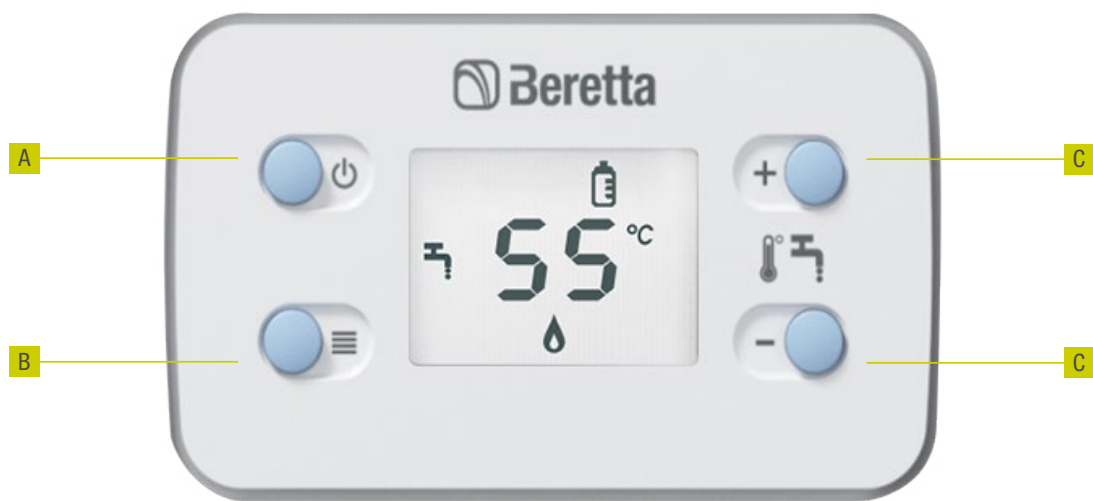









KEY:

- A** ON/OFF/Reset button
- B** MENU-CONFIRM button

- C** Buttons + and - allow to:
 - increase or decrease the domestic hot water temperature, displaying it on the display
 - navigate through the various available functions and change the value of a parameter

DISPLAY ICONS

-  **anti-scald function**, to set the maximum domestic hot water supply temperature
-  **general alarm** icon that, in combination with other icons and/or codes, identifies the fault type
-  **wrench function**, signalling the necessity of maintenance / technical intervention, or indicating the entry into the technical menu
-  **function for the choice of temperature measurement:** degrees Celsius or Fahrenheit
-  **flame presence** icon, indicating burner ON
-  **exhaust fumes** fault code
-  **keyboard lock function**, useful f.i. in the presence of children to avoid tampering
-  **flame lock-out**, in the event of a fault
-  **solar function**, that can be activated when combined with solar thermal systems for DHW production

TECHNOLOGY AND ADVANTAGES

Instantaneous room-sealed gas water heater, with natural gas and LPG specific order codes, available also as FLEX version

Abundant domestic hot water production at Δt 25 ° C:
12, 13 or 16 liters / min

Electronic ignition and ionization flame control

Innovative hyperstochiometric and cooled burner, with low emissions (details on the following page)

Air - gas combustion with constant efficiency

Wide flame modulation (1: 3) allowing a perfect stability of the domestic hot water supply temperature, even with minimum hot water draw-off

New user interface with back-lit display with icons and 4 buttons, to easily navigate the menu and make adjustments

Even more compact dimensions and easy installation

Mounting template supplied as standard

Availability of the FLEX model, in the 11 litres version, for an easy connection to the DHW circuit, with flexible fittings and water tap supplied as standard

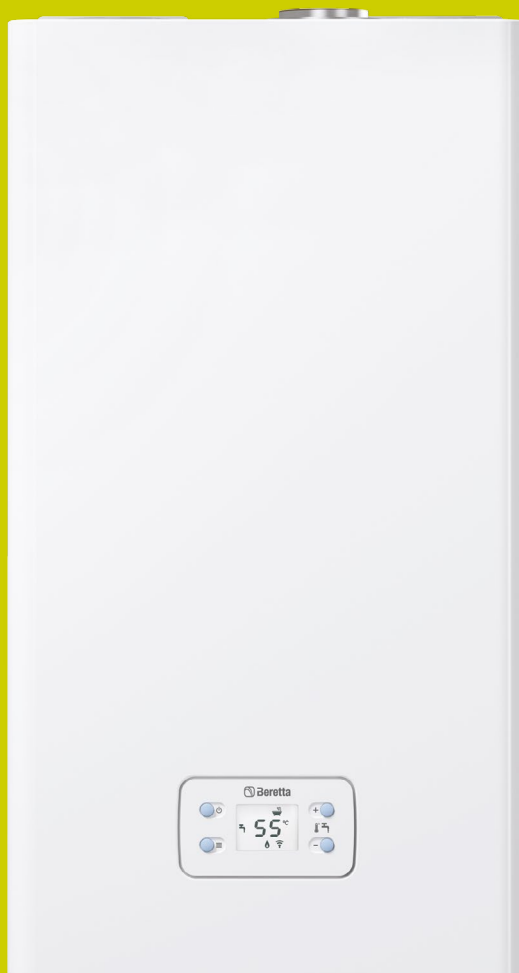

- | | | | |
|---|------------------|----|---------------------------|
| 1 | Limit thermostat | 6 | Gas valve |
| 2 | By-pass | 7 | Flow meter |
| 3 | NTC probe | 8 | Filter |
| 4 | Heat exchanger | 9 | Domestic hot water outlet |
| 5 | Cooled burner | 10 | Cold water inlet |

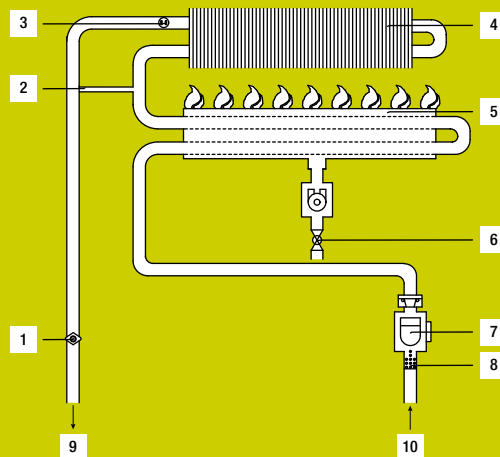

TECHNOLOGY AND ADVANTAGES

Last generation burner, low NOx

The new line IDRABAGNO Lx is able to meet the most demanding requirements in terms of low emissions, in force since September 2018 according to the (EU) Regulation 814/2013, which requires that **emissions of nitrogen oxides shall be equal or less than 56 mg/kWh**. Thanks to the **innovative Idrabagno Lx burner, of hyperstichometric type**, the flame is fed by an air-gas mixture in excess of that required for combustion, obtaining a very low flame temperature as a result. From this characteristic, combined with the **burner, cooled by the**

water of the water heater circuit, derives a **significant lowering of carbon monoxide and nitrogen polluting emissions**, produced by the combustion, such as to satisfy with flying colors the new limits set by the recent European Regulation. The **high thermal flow**, together **with the wide modulation flame** (up to 45% of the nominal flow), complete the profile of the water heater in terms of performance, while offering **the maximum comfort to the end-user**.

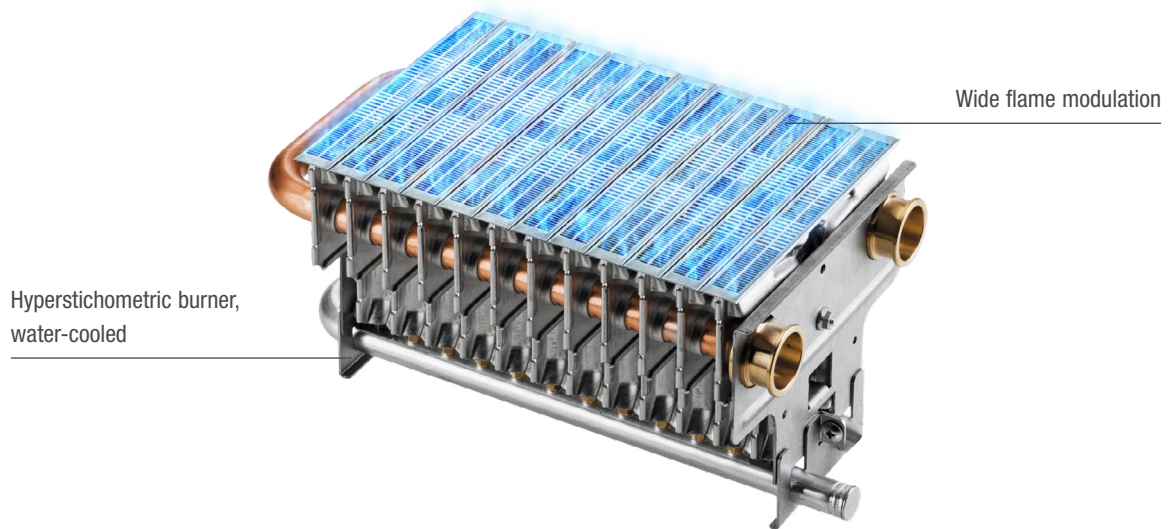

Solar thermal connection

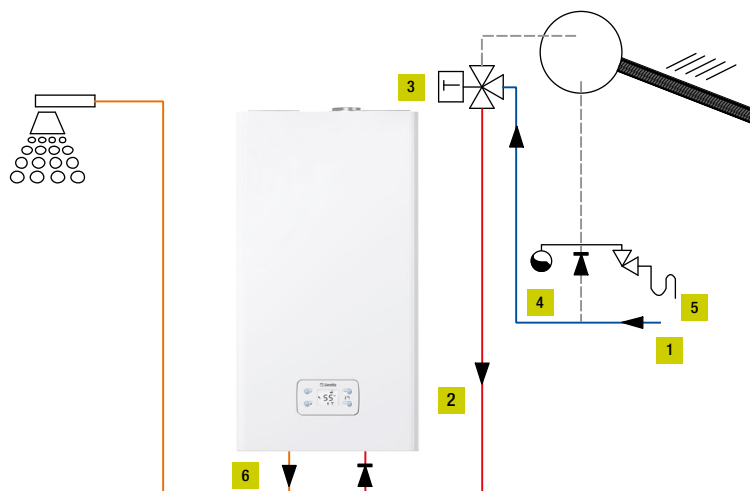

The new IDRABAGNO Lx features a solar function that can be activated through the control panel, if the water heater is installed in a solar thermal system for the production of DHW, allowing maximum energy savings.

- 1 Cold water
- 2 Cold water inlet
- 3 Thermostatic valve
- 4 Expansion vessel
- 5 Safety group
- 6 Domestic hot water outlet

This scheme has only an indication purpose. Please follow the instructions of the installer manual.

TECHNICAL DRAWINGS

Idrabagno Lx 11, 13, 17 - Idrabagno Lx 11 FLEX

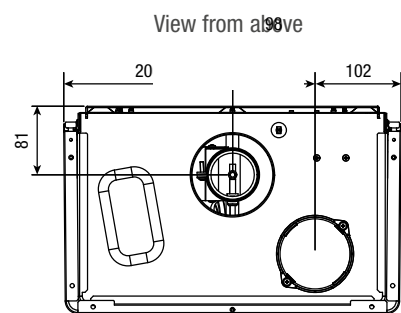
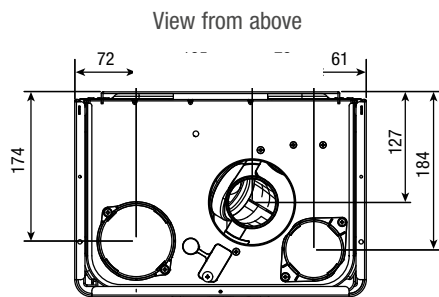
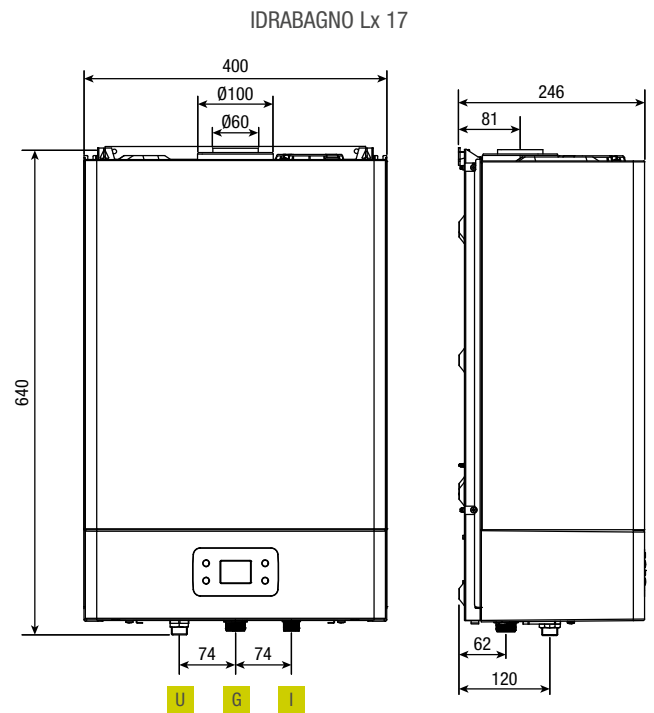
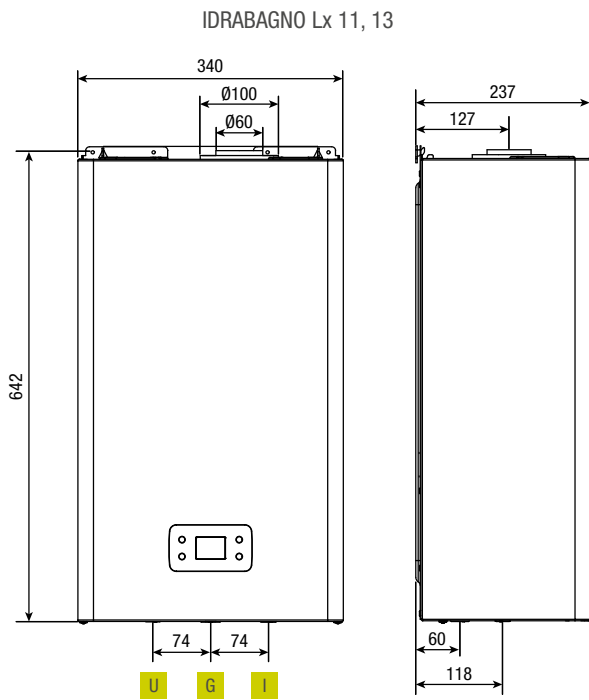

Concentric flue system (Ø60-100)

IDRABAGNO Lx 11, 13

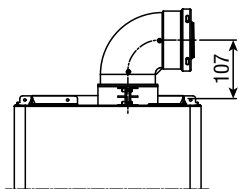

Twin flue system (Ø80)

IDRABAGNO Lx 11, 13

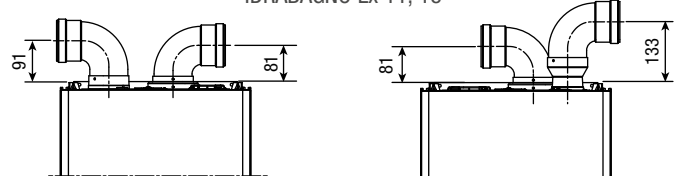

IDRABAGNO Lx 17

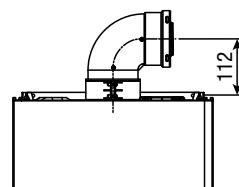

IDRABAGNO Lx 17

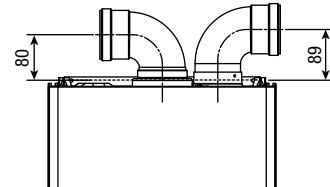

KEY: **G** gas

I DCW Inlet

U DHW Outlet

TECHNICAL DATA

CHARACTERISTICS AND MODELS AVAILABLE	U.O.M.	IDRABAGNO Lx 11 IDRABAGNO Lx 11 Flex	IDRABAGNO Lx 13	IDRABAGNO Lx 17
Product order code	NG	20143031 20143033 (Flex)	20143035	20143037
	LPG	20143032 20143034 (Flex)	20143036	20143038
ENERGY LABEL SPECIFICATIONS ACCORDING TO EUROPEAN DIRECTIVE ErP				
Domestic water seasonal energy efficiency class	F → A+*	A	A	A
Domestic water load profile	-	M	L	L
Domestic water seasonal energy efficiency (η _{wh})	%	75,4	80,2	80,2
Daily fuel consumption (Q _{fuel})	kW / h	8,109	15,175	15,175
Annual fuel consumption (AFC)	GJ	6	11	11
Daily electrical energy consumption (Q _{elec})	kWh	0,065	0,069	0,069
Annual electrical energy consumption (AEC)	kWh	14	15	15
Sound power level, indoor (LWA)	dB(A)	51	51	51
Nitrogen oxide emissions (Nox)	mg / kWh	33	33	40
CHARACTERISTICS				
Type	-	room-sealed	room-sealed	room-sealed
Draft	-	forced draft	forced draft	forced draft
Ignition	-	ionization (electrical)	ionization (electrical)	ionization (electrical)
Flame control	-	ionization	ionization	ionization
Flame modulation	-	electronic	electronic	electronic
Hot water flow rate Δt = 30 °C	litres / min	9,6	10,7	13,2
Nominal heat input (G20- G30 - G31)	kW	22,50	25,00	30,00
Nominal heat output (G20- G30 - G31)	kW	20,16	22,45	27,60
WATER				
DHW temperature selection range	°C	36 - 65	36 - 65	36 - 65
Minimum / nominal / maximum pressure	bar	0,2 / 2 / 10	0,2 / 2 / 10	0,2 / 2 / 10
Water connections	∅	1/2 "	1/2"	1/2"
GAS				
Natural gas nominal supply pressure (G20)	mbar	20	20	20
LPG nominal supply pressure (G30 / G31)	mbar	28-30 / 37	28-30 / 37	- / 37
Gas connections	∅	3/4 "	3/4 "	3/4"
Flue exhaust gases temperature (min-max) G20 / G30 / G31	°C	120-71 / 121-64 / 124-60	128-71 / 123-63 / 129-69	135-72 / - / 137-71
CONCENTRIC FLUE AND AIR-INTAKE PIPES ∅ 60 / 100				
Maximum length	m	3,5	3,5	2,6
Loss for the insertion of a 45° / 90° bend	m	1 / 1,5	1 / 1,5	1 / 1,5
TWIN FLUE AND AIR-INTAKE PIPES ∅ 80				
Maximum length	m	15 + 15	15 + 15	6 + 6
Loss for the insertion of a 45° / 90° bend	m	1,2 / 1,7	1,2 / 1,7	1,2 / 1,7
ELECTRICAL VALUES				
Electrical absorbed power	W	41	41	41
Power supply voltage	V/Hz	230/50		
Electrical protection level	-	IPX4D		
DIMENSIONS AND WEIGHT				
Dimensions (H×L×W)	mm	642×340×237	642×340×237	640×400×246
Net weight	kg	19	19	21
Available gas versions	-	natural gas / LPG	natural gas / LPG	natural gas / LPG
Flexible accessories as standard	-	only FLEX version	no	no
Domestic water tap as standard	-	only FLEX version	no	no

* The range of energy efficiency class of this products category is between F and A+.



Trading Address:

Via Risorgimento, 23 A
23900 Lecco (LC) Italy
Tel. +39 0341 277111
Fax +39 0341 277263

www.berettaheating.com

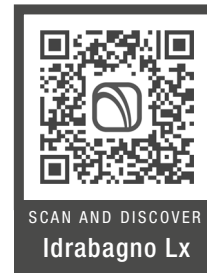

27024081 - EN - rev.00 - 06/2025



©2025 Carrier. All rights reserved.
All product and service marks mentioned in this document are the property of their respective owners.

Beretta reserves the right to change the information and specifications contained in this document at any time and without notice. The contents and information herein have to be considered for informational purposes only and are not intended to provide legal or professional advice. This document, therefore, cannot be considered binding on third parties.