



HYBRID AND CONNECTED SOLUTIONS

Hi, Comfort



Hi, Comfort

YOUR HOME **COMFORT**
UNDER CONTROL,
WHEREVER YOU ARE



Hi, Comfort T300

Hi, Comfort, Beretta's platform of IOT solutions, is now enriched with advanced room control **Hi, Comfort T300**. The **new control**, featuring a stylish and modern design, in addition to remote comfort management via App, integrates advanced functions, up to the **management of a hybrid system from App, wherever you are.**

Hi, Comfort T300, THE FEATURES



CHRONO-THERMOSTAT

Hi, Comfort T300 operates as a chrono-thermostat and allows you to set heating and cooling time schedule for a proper balance between comfort and consumption.



MANAGER FOR HYBRID SYSTEMS

Efficient management of multiple energy sources; Hi, Comfort T300 is the real brain of the system, managing boilers, heat pumps and solar thermal.



REMOTE CONTROL VIA APP

Maximum flexibility: with the use of Hi, Comfort App, home comfort will always be within reach of the smartphone.



ROOM CONTROL

The Hi, Comfort T200 thermostat, combined in RF with the Hi, Comfort T300, allows optimal control of comfort within each room.



IMMEDIATE AND SIMPLE USE

Excellent user experience on chrono-thermostat and App, thanks to renewed graphics and a menu tree that follows the tradition of previous Beretta controls.

TYPICAL SYSTEM CONFIGURATION SCHEME WITH T300

Hi, Comfort T300 is in communication via ModBUS with the heating and cooling generation section (boiler and heat pump) and in wireless (radio) communication with any Hi, Comfort T200 for local control. With the built-in gateway it then connects to the home router to provide Internet access and use of Hi, Comfort App.



T200

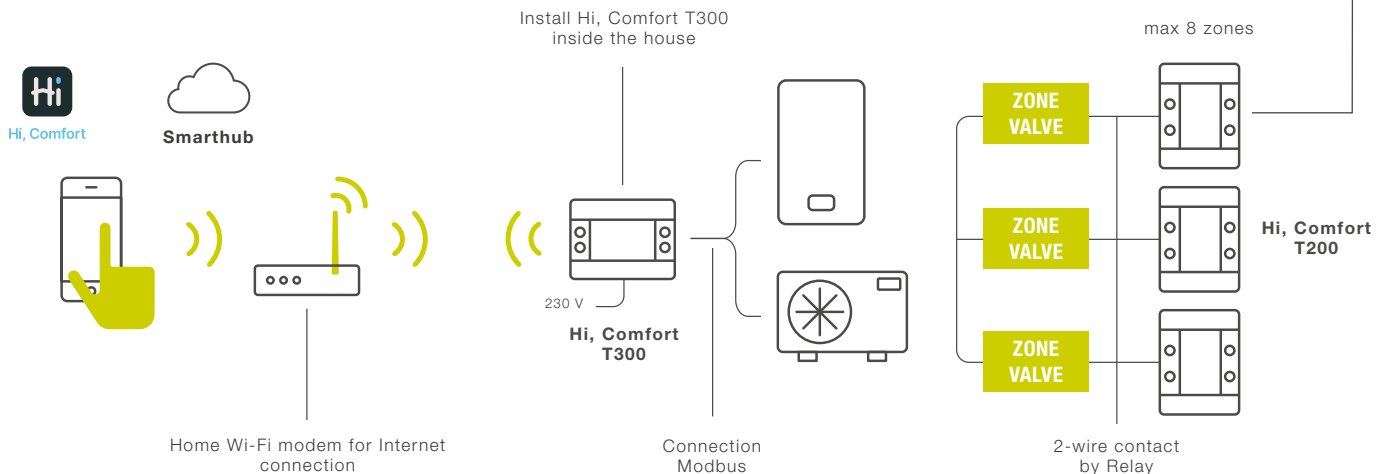

Hi, Comfort T300 IN HYBRID SYSTEMS

Hi, Comfort T300, with integrated gateway, can manage up to 3 zones via expansion PCB and, in the case of hybrid installation, operates as a true System Manager for consumption optimization. All this is also via the Hi, Comfort App. Hi, Comfort T300 is compatible with the latest generation boilers and heat pumps for optimized home comfort management even in hybrid installations. The screen graphics of Hi, Comfort T300 are completely new, easy to read and do not tire the eyes. The icons are self-explanatory while the menu tree reproduces the configuration logic of Beretta's traditional thermostats.

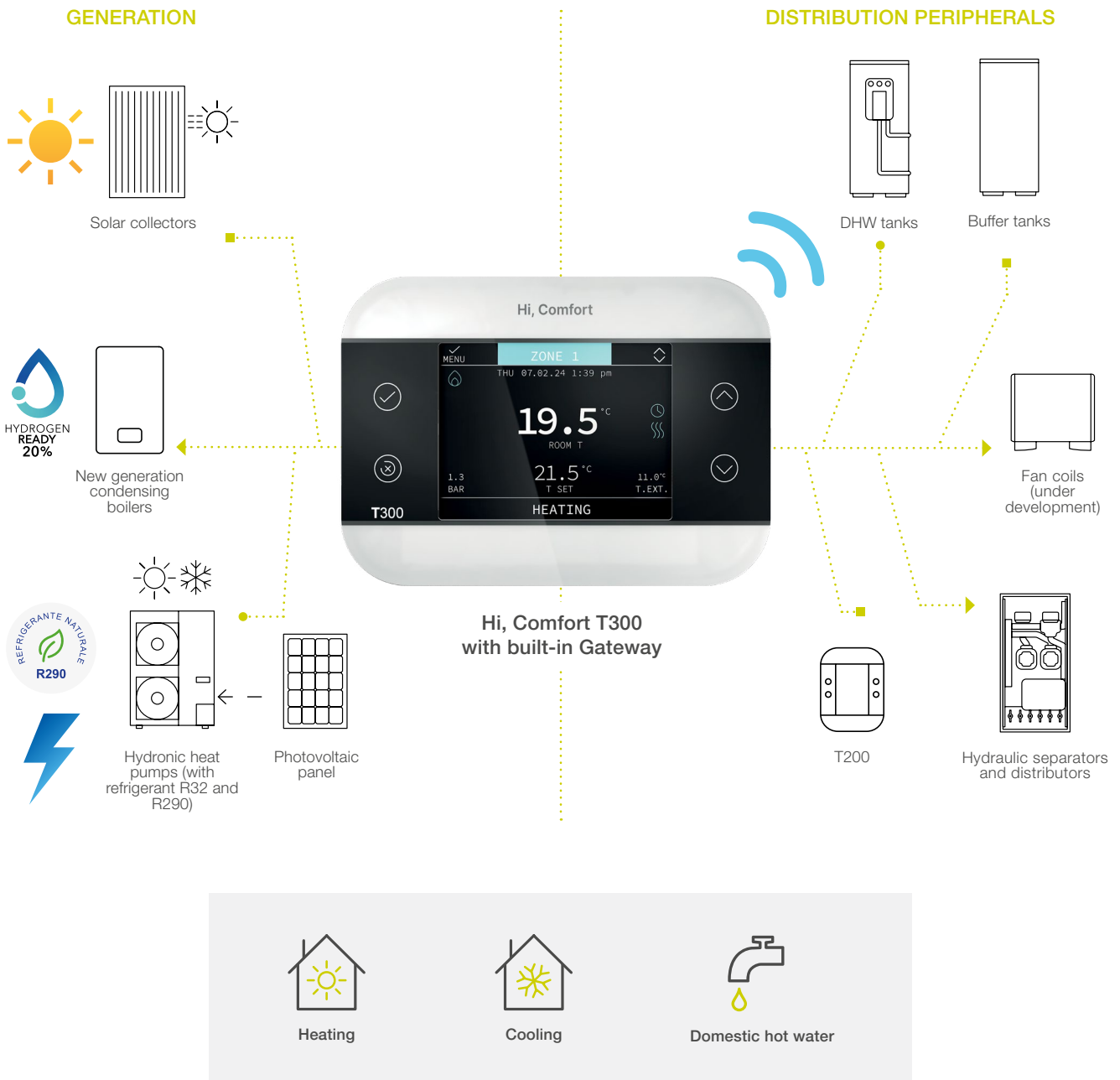













NB: Hi, Comfort T300 is compatible with some specific products in Beretta's offering for hybrid systems. Please refer to the Catalog List.

Hi, Comfort T200, FOR MADE-TO-MEASURE COMFORT



Hi, Comfort T200 is a new accessory that, when combined in RF with the Hi, Comfort T300 advanced room control, allows for optimal comfort control within each room of the home. Equipped with an innovative design and touch key technology for menu navigation, it offers a dual installation solution: wall-mounted, or, via dedicated support, placed on any piece of furniture in the room. It is also compatible with Hi, Comfort App.

T300 COMPATIBILITY TABLE WITH BERETTA OFFER

		BOILER	HEAT PUMP	IOT
 T300	FULL GAS	  MYNUTE EVO X EXCLUSIVE EVO X		✓
	FULL ELECTRIC		   HYDRO UNIT P HYDRO UNIT M EXCLUSIVE AGILE	✓
 T200	HYBRID*	  MYNUTE EVO X EXCLUSIVE EVO X	   HYDRO UNIT P HYDRO UNIT M EXCLUSIVE AGILE	✓

*Hi, Comfort T300 is compatible with some specific products in Beretta's offering for hybrid systems. See the Catalog List for possible combinations of boiler and heat pump.

PROPRIETARY APP Hi, Comfort T300

Hi, Comfort T300, in addition to the advanced remote comfort management functions of individual compatible Beretta products, can also control an entire system via App, easily and intuitively.

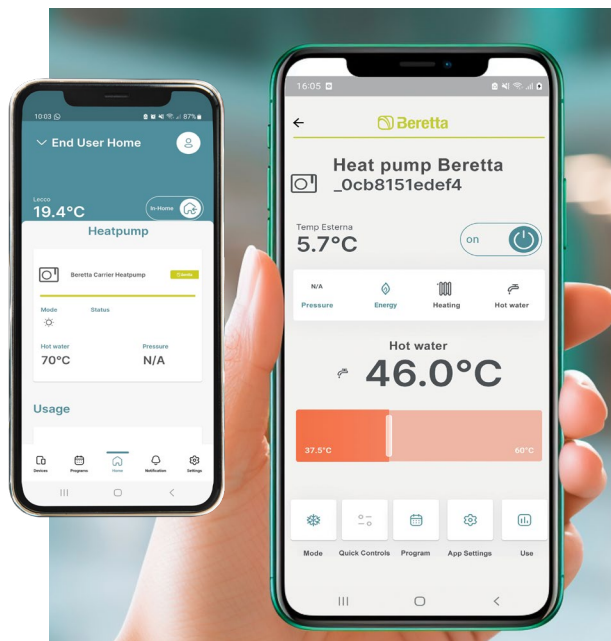

Hi, Comfort T100

YOUR COMFORT AT YOUR FINGERTIPS

Hi Comfort T100 can be used as a traditional thermostat or in smart mode through the Hi, Comfort App, when combined with its Hi, Comfort G100-W Wi-Fi Box. The App is free to download for Android and iOS systems and allows users to monitor states, remotely set domestic hot water temperature, and define boiler settings easily and securely. In addition, installing Hi, Comfort T100 is quick and easy and, in case of replacing an old thermostat, does not require interventions on the home's electrical system. Hi, Comfort T100, which is battery-powered, also allows "wireless" installation, if you equip the system with a radio frequency receiver.

- Complete control with backlit display for managing home comfort, even remotely with Smartphone and Tablet
- Modern and easy-to-use App with innovative functions
- Remote control of Beretta boilers in evolved mode and all boilers in ON/OFF mode
- Versatile communication: ON/OFF and OTBus both wired and wireless

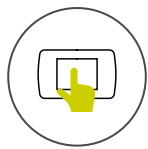

**INTUITIVE
INTERFACE**



**QUICK AND EASY
INSTALLATION**



**HIGH
SECURITY
STANDARDS**

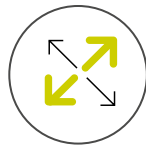

**EXTENDED
COMPATIBILITY**



ADVANCED SMART CONTROL

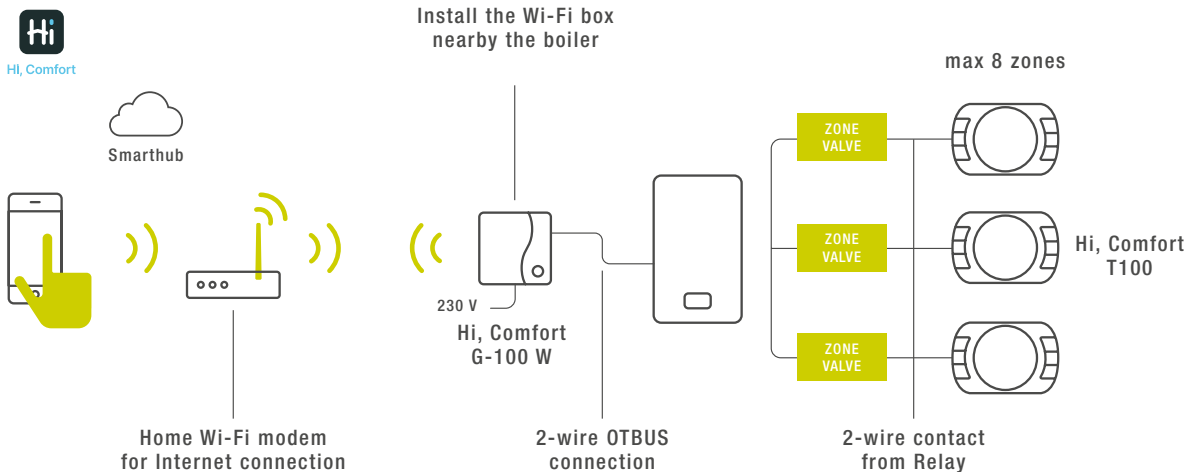

Hi, Comfort, APP

FOCUS ON WELL-BEING RESPECTING THE ENVIRONMENT

Hi, Comfort is the app designed and created to make managing your home comfort easy. You will be surprised by how simple it is to install and use: thanks to its user-friendly icons, you can intuitively access all its features.



ALL THE SIMPLICITY OF HI, COMFORT ALWAYS AT YOUR FINGERTIPS

Hi, Comfort cares about your home's well-being and helps to avoid unnecessary energy waste, ensuring increasingly green comfort: with Hi, Comfort, benefiting the environment translates into financial savings! Start conveniently managing your heating system remotely, wherever you are and at any time.



UNIVERSAL COMPATIBILITY

The Hi, Comfort app is compatible with a wide range of products (continuously updated) and works across multiple residential heating solutions. Thanks to its universality, you can monitor your home remotely and without restrictions.



SAFETY AND RELIABILITY

Hi, Comfort is the trustful app: it offers safe and convenient solutions for home comfort, respecting the environment. With Hi, Comfort, you can keep a check on the operating status of your products. Thanks to error reporting, you can quickly resolve any issues with your heating system.



Hi, Comfort

FROM NOW,
MANAGING YOUR COMFORT
HAS NEVER BEEN SO EASY
THANKS TO HI, COMFORT,
OUR NEW IOT PLATFORM.

The HI, COMFORT platform, which includes new generation of boilers, smart thermostats and App is the beginning of a new era for your comfort.

FOR MORE DETAILS ON Hi, Comfort SOLUTIONS
REFER TO THE SITE
www.hi-comfort.com



Riello S.p.A.
Via Ing. Pilade Riello, 7
37045 Legnago (VR) - Italy
tel. +39 0442 630111
www.berettaheating.com

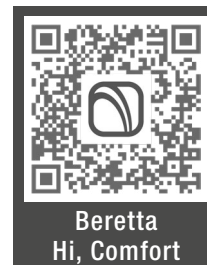

Beretta reserves the right to change the information and specifications contained in this document at any time and without notice. The contents and information herein have to be considered for informational purposes only and are not intended to provide legal or professional advice. This document, therefore, cannot be considered binding on third parties.

© Riello S.p.A. All rights reserved.