

User manual

REC 10MH

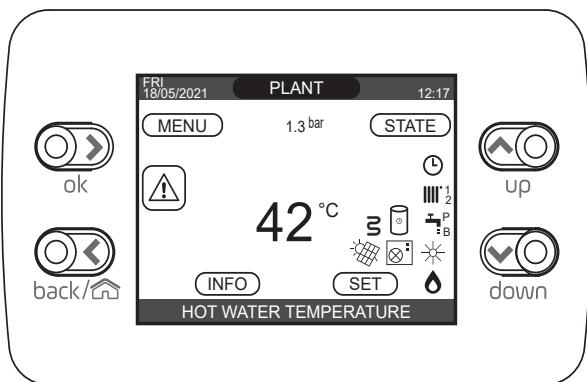

- 1. **GENERAL INFORMATION** 4
- 2. **GENERAL WARNINGS** 5
- 3. **FOR YOUR SAFETY** 6
- 4. **USER INTERFACE CONTROL PANEL** 7
- 5. **INITIAL SCREEN** 10
- 6. **PLANT** 10
- 7. **STATE** 11
 - 7.1 **BOILER or SYSTEM** 11
 - 7.1.1 **OFF** 11
 - 7.1.2 **Heating and hot water** 11
 - 7.1.3 **Hot water only** 11
 - 7.2 **DHW (only available with a heating-only boiler connected to a storage tank)** ... 12
 - 7.2.1 **Auto** 12
 - 7.2.2 **Manual** 12
 - 7.2.3 **DHW BOOST (only with full electric)** 12
 - 7.3 **MAIN ZONE** 12
 - 7.3.1 **ON** 13
 - 7.3.2 **AUTO** 13
 - 7.3.3 **MANUAL** 13
 - 7.3.4 **OFF** 13
 - 7.4 **HEAT PUMP (if available)** 13
 - 7.5 **ANTILEGIO CUT OFF (only if awater tank is available)** 14
- 8. **SET** 15
 - 8.1 **HEATING** 15
 - 8.2 **DHW** 16
 - 8.3 **WATER TANK SETPOINT (domestic hot water from the water tank, if available)**. 16
 - 8.4 **PREHEATING (available with combined boiler)** 17
 - 8.5 **BIBERON FUNCTION** 17
 - 8.8 **COOLING (available if a heat pump enabled for cooling is installed)** 18
 - 8.9 **BOOST SETPOINT and BOOST ACTIVE TIME (in electric systems only)** 18
- 9. **INFO** 19
- 10. **MENU** 20
 - 10.1 **SETTINGS** 20
 - 10.1.1 **TIME AND DATE** 20
 - 10.1.2 **DAYLIGHT SAVING TIME** 20
 - 10.1.3 **LANGUAGE** 20
 - 10.1.4 **BACKLIGHT** 21
 - 10.2 **TIME SCHEDULE** 21

11. TIME SCHEDULE	22
11.1 ADD	23
11.2 MODIFY	24
11.3 DELETE	25
11.4 COPY	26
12. FAULTS	27
12.1 LIST OF BOILER FAULTS	27
12.2 LIST OF ZONE FAULTS	28
12.3 LIST OF HEAT PUMP FAULTS (*)	28
12.4 LIST OF SOLAR FAULTS (if present)	28
12.5 RESET FUNCTION	29
13. HOW TO USE...	30
13.1 MODE	30
13.2 AMBIENT SETPOINT	31
13.3.1 Set boiler (chronothermostat)	32
13.3.2 Settings	32
13.3 MENU	32
13.3.3 Time schedule (ambient regulator and chronothermostat)	33
14. MULTI-ZONE MANAGEMENT	34
14.1 FAULTS	35
14.1.1 List of timed thermostat faults	35

In some parts of the booklet, some symbols are used:



= for actions requiring special care and adequate preparation



= for actions THAT MUST NOT be performed

Depending on the type of application, some of the functions described in this manual might not be available.

1. GENERAL INFORMATION

READ THIS MANUAL CAREFULLY TO ENSURE THE CORRECT USE OF THE CONTROL PANEL.

TYPES OF USE

The control panel can fulfil different functions depending on the settings made at the time of installation:

1) Machine interface function (MASTER)

In this case, the control panel manages primarily the operation of the system components, without controlling the ambient temperature (for which an external room thermostat is needed).

If enabled however, it can control not only the system interface functions but also the temperature of the room where it is installed.

2) Timed thermostat function

In this case, the control panel only controls the temperature of the room where it is installed. Refer therefore to the specific paragraphs on the basis of the control panel function.

WARNINGS













- The control panel must be installed in the room that can most easily be accessed by you in order to check the ambient temperature.
- To allow for an easier reading of the display, the control panel should be positioned, as the regulations require, 1.5 metres from the floor.
- The control panel receives a low voltage power supply.
- The control panel must always be kept away from heat sources or draughts: these may affect the accuracy of the readings of the built-in room thermostat.

- Do not open the panel for any reason: its operation does not require any maintenance.
- Do not apply pressure on the glass of the LCD display: this may damage the glass itself and cause display problems.
- Use a dry cloth only to clean the display: possible infiltration could damage the LCD.

















At the end of its working life, the product must not be disposed of as solid urban waste; it must be handed over to a sorted waste collection centre.

2. GENERAL WARNINGS

-  The instruction manual is an integral part of the product and it must therefore be kept carefully and must accompany the appliance; if it gets lost or damaged, another copy must be requested from After Sales Service.
-  The appliance must only be installed and serviced by qualified personnel, in accordance with the regulations in force and UNI 7129-7131 (and subsequent amendments).
-  For the installation, you are advised to contact specialised personnel.
-  The appliances must be used as intended by the manufacturer. No contractual or extra-contractual responsibility can be assumed for harm to people or animals or damage to property resulting from incorrect installation, adjustment and maintenance or improper use.
-  The safety and automatic adjustment appliances must not be modified, during the system life cycle, by the manufacturer or supplier.
-  The job of the hybrid system is to produce hot water, so it must be connected to a heating/cooling system and/or a domestic hot water distribution network compatible with its performance and output.
-  In the event of water leakage, shut off the water supply and contact the After Sales Service personnel immediately.
-  In the event of absence for long periods time, close the gas supply and switch off the main electricity supply switch. If there is a risk of freezing temperatures, drain the heating and DHW system.
-  To use the automatic anti-freeze protection function for the boiler and heat pump, the appliances must be able to switch on. This means that any lockout condition (e.g. lack of gas/electricity supply, or safety device intervention) will deactivate the protection.
-  From time to time, check that the operating pressure of the hydraulic system does not fall below 1 bar.
-  In the event of failure and/or malfunctioning, deactivate the appliances but do not try to repair or intervene directly on them.
-  Appliance maintenance must be carried out at least once a year: scheduling it in advance with After Sales Service will prevent wasted time and money.
-  The technician - qualified in accordance with the regulations in force (installing or servicing company) - must define the requirements and frequency of the system inspection and maintenance interventions to guarantee the required safety. If this information is not provided, refer to the manufacturer's indications.

3. FOR YOUR SAFETY

The use of the boiler requires strict observance of certain basic safety rules:

-  Do not use the appliance in any manner other than its intended purpose.
 -  It is dangerous to touch the appliance with wet or damp body parts and/or in bare feet.
 -  Under no circumstances should you cover the intake grids, dissipation grids and ventilation vents in the installation room with cloths, paper or any other material.
 -  Do not activate electrical switches, telephones or any other object that causes sparks if there is a smell of gas. Ventilate the room by opening doors and windows, and close the central gas tap.
 -  It is forbidden to disconnect the boiler from the electricity supply and close the gas tap if there is a risk of the temperature falling below zero, as the 1st level anti-freeze system would be disabled.
 -  Do not place anything in the boiler..
 -  Do not perform any cleaning operation until the appliance has been disconnected from the main electricity supply.
 -  Do not block or reduce the size of the ventilation vents in the installation room.
 -  Do not leave containers and inflammable products in the installation room.
 -  Do not attempt to repair the appliance in the event of failure and/or malfunctioning.
 -  It is dangerous to pull or twist the electric cables.
-  It is forbidden to intervene on sealed elements.
 -  Children or unskilled persons must not use the appliance.
 -  It is forbidden to obstruct the condensate drain outlet.

4. USER INTERFACE CONTROL PANEL

The REC10MH remote control has the function of a machine interface, as it displays the system settings and allows the parameters to be accessed. It is also capable of providing multi-zone control and a weekly room thermostat function.

The system may be equipped with several REC10MH units, but **ONLY ONE** serves as a machine interface (MASTER); any others will work as timed thermostats for regulating the ambient temperature in the zones with which they are associated. In the latter case, the main screen of the user interface shows the environmental data of the zone to which it is related.

The user interface unit features a backlight liquid crystal display.

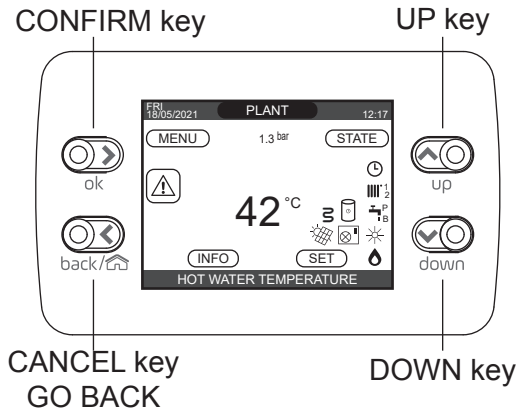













	ok	Confirm
	back	Return to the previous screen / CANCEL selection
		Return to the main screen (press > 2 sec.)
	up	To choose from PLANT, STATE, SET, INFO, MENU and to navigate through the sub-menus scrolling upwards
	down	To choose from PLANT, STATE, SET, INFO, MENU and to navigate through the sub-menus scrolling downwards

The centre of the main screen shows the temperature of the domestic hot water probe, unless there is a heat request in progress; in this case, it shows the delivery temperature of the source active in that moment (boiler, or heat pump if installed). In any case, the meaning of the value is indicated in the bottom part of the display.

The value expressed in bar refers to the system water pressure.

The top of the screen shows the current date and time, as well as the outdoor temperature (if available).

	This icon indicates that the OFF operating status mode has been set. Each ignition request is ignored except for the anti-freeze function. The pump anti-lock and 3-way and anti-freeze functions remain active.
	This icon indicates that HEATING AND HOT WATER mode has been selected (HEATING function enabled). If a heating request from the main zone is in progress, the icon will be flashing. If a heating request from the supplementary zone is in progress, the number 1 or 2 will be flashing.
	This icon indicates that COOLING is active in HOT WATER ONLY status. If a cooling request from the main zone is in progress, the icon will be flashing. If a cooling request from the supplementary zone is in progress, the number 1 will be flashing.
	This icon indicates that the DHW circuit is enabled on the boiler. When a domestic hot water request is in progress, the icon flashes. <ul style="list-style-type: none"> • Only with heating-only boilers with a water tank: outside the DHW enabling time bands, this icon will be crossed out. • Only with a combined boiler: the P above the DHW icon indicates that the boiler pre-heating function is enabled; the P when flashing indicates that a pre-heating request is in progress. • The B below the DHW icon indicates that the DHW BOOST function is active.
	When the “heating timer programming” function is enabled, this icon indicates that the heating of the relative zone is in AUTOMATIC mode (the management of the heating requests follows what has been set with the timer). Outside the heating enabling time bands, this icon will be crossed out.
	When the “heating timer programming” function is enabled, this icon indicates that the heating of the relative zone is in MANUAL mode. Heating request management does not follow the timer programming that has been set, but is always active).
OFF	When the “heating timer programming” function is not enabled, this icon indicates that the main zone has been set to OFF (not active).
	This icon indicates that heat pump management is enabled. When the heat pump is operating, the icon flashes.
	This icon indicates that solar system management is enabled (if available). The icon flashes when the solar system’s circulator pump is in function.
	This icon indicates that the system is detecting the presence of a flame.
	This icon indicates the presence of an anomaly, and is always flashing.
	Only with a combined boiler: this icon indicates the presence of a water tank and a heat pump enabled for DHW. The icon appears crossed out with an “X” when the system is operating outside the time bands of the domestic hot water heat pump, while it flashes when the heat pump is working to fill the storage cylinder
	This icon indicates that photovoltaic system management is enabled. If the icon is flashing, this means the electricity production from the photovoltaic system is adequate (contact closed). The system uses the energy available.
	This icon indicates that an electric heater is connected to the system. It flashes when the electric heater for DHW integration (water tank) is active.

MENU

SETTINGS

- TIME & DATE
- DAYLIGHT SAVINGS TIME
- LANGUAGE
- BACKLIGHT

TIME SCHEDULE

- MAIN
- ZONE 1
- ZONE 2
- DHW
- HP DHW

BIBERON

DEFAULT VALUE FACTORY SET	MINIMUM VALUE	MAXIMUM VALUE	ACCESS LEVEL NOTES
			USER
			USER
FUNCTION ACTIVE	FUNCTION NOT ACTIVE	FUNCTION ACTIVE	USER
		ENGLISH/ITALIANO/....\	USER
5 min	1 min	15 min	USER
			USER
			USER: only if POR = 1
			USER: only if POR = 1 and zone added
			USER: only if POR = 1 and zone added
			USER: only with water tank
			USER: only if HP present and enabled for DHW integration
			USER: only if instantaneous configuration and water tank with probe
0	0	1	

STATE

- BOILER
- DHW
 - ANTILEGIO CUT OFF
 - DHW BOOST
- MAIN ZONE
- HEAT PUMP
 - ACTIVATE/DEACTIVATE NIGHT REDUCTION
 - NIGHT MODE START TIME
 - NIGHT MODE STOP TIME

DEFAULT VALUE FACTORY SET	MINIMUM VALUE	MAXIMUM VALUE	ACCESS LEVEL NOTES
OFF		OFF/SUMMER/WINTER	USER
AUTO		AUTO/MANUAL	USER
			USER, when ANTILEGIONELLA in progress
0	0	1	USER: (only full electric)
AUTO		AUTO/MANUAL/OFF (if POR=0)	USER
ON		ON/OFF (if POR=1)	
			on hybrid only if heat pump added
FUNCTION NOT ACTIVE	FUNCTION ACTIVE	FUNCTION NOT ACTIVE	USER
20:00	00:00	23:59	USER: only if NIGHT REDUCTION active
09:00	00:00	23:59	USER: only if NIGHT REDUCTION active

SET

- HEATING
- DHW
- COOLING
- PREHEATING
- WATER TANK SETPOINT
- BOOST SETPOINT (see par. 8)
- BOOST ACTIVE TIME (see par. 8)

DEFAULT VALUE FACTORY SET	MINIMUM VALUE	MAXIMUM VALUE	ACCESS LEVEL NOTES
80,5 (HT) - 45°C (LT)	MIN CH SET	MAX CH SET	USER
0°C	-5°C	+5°C	USER, if EXTERNAL SENSOR connected and REQUEST TYPE TA
60,0°C	37,5°C	60°C	USER
18°C	4°C	20°C	if you work at a fixed point
0	-5	+5	if you work with climatic curves
0	0	2	USER (only instantaneous boiler)
60°C	37,5°C	60°C	USER (with water tank)
60°C	50°C	80°C	USER (only full electric)
15min	1min	30min	USER (only full electric)

5. INITIAL SCREEN

At switch-on, the user interface might:

- request the setting of the time and date (“10.1.1 TIME AND DATE”)
- display the firmware version and require a button to be pressed in order to continue.

Press “**up**” and “**down**” to scroll through the functions in the following order:

- PLANT
- STATE
- SET
- INFO
- MENU

Press “**ok**” to access the settings of the selected function (apart from PLANT).

The “**back**” key will be inactive (apart from PLANT).

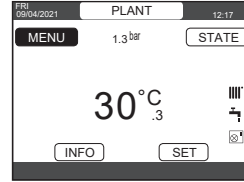

6. PLANT

This item does not represent any specific function. Instead, it indicates the zone that the data on the initial screen refer to, and the zone that the settings accessed via other functions refer to.

The presence of one or more zones in addition to PLANT depends on the installation's configuration. For this reason, one or more of the zones cited below may not be present in your configuration, or may be identified with a different name.

To change the zone, select PLANT (pressing “**up**” or “**down**” if necessary).

Now use the “**ok**” and “**back**” keys to select another zone, following this sequence:

- PLANT
- MAIN ZONE (if managed by the user interface or an ambient probe)
- ZONE 1 (if configured)
- ZONE 2 (if configured)

The TIME and DATE, DAYLIGHT SAVINGS TIME, LANGUAGE and BACKLIGHT settings are independent of the zone selected.

The information contained in the INFO menu is independent of the selected zone.

If MAIN, ZONE 1 or ZONE 2 is selected, no DHW parameters can be set.

7. STATE

The operating mode is set from the STATE menu, as follows:

- hybrid: BOILER • DHW (only in HW TANK configuration) • MAIN ZONE • HEAT PUMP (if available).
- electric SYSTEM • MAIN ZONE • HEAT PUMP.

Note: MAIN ZONE is only visible in this menu if the zone is managed by a room thermostat.

HEAT PUMP is only visible if a heat pump is connected to the system.

hybrid

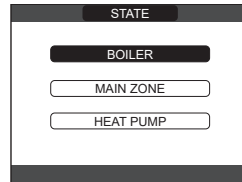

electric

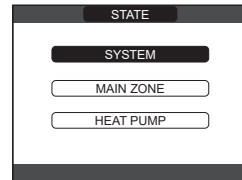

7.1 BOILER or SYSTEM

When this function is selected, the status of the boiler or system can be set with one of the following options:

- OFF
- HOT WATER ONLY
- HEATING AND HOT WATER

The highlighted status is that which is currently selected. To select a different status, highlight it with “up” or “down” and then press “ok” to confirm.

Once the selection has been validated, the display returns to the STATE screen.

Press “back” to return to the initial screen without making any selection.

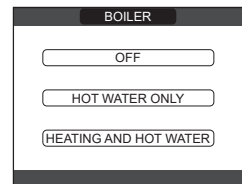

7.1.1 OFF

If **OFF** is selected, the system shuts off.

7.1.2 Heating and hot water

Selecting **HEATING AND HOT WATER**, the system produces domestic hot water and water for heating.

7.1.3 Hot water only

Selecting **HOT WATER ONLY**, the system produces domestic hot water and, if a heat pump is configured, also water for cooling. Heating is not enabled.

7.2 DHW (only available with a heating-only boiler connected to a storage tank)

When this function is selected, the status of the DHW can be set with one of the following options:

- AUTO
- MANUAL.

The highlighted status is that which is currently selected. To select a different status, highlight it with the “+” and “-” key, then press “ok”.

Once the selection has been validated, the display returns to the STATE screen.

Press “back” to return to the initial screen without making any selection.

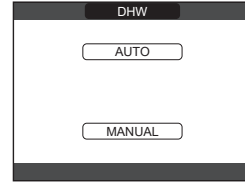

7.2.1 Auto

Selecting AUTO, the DHW requests are managed on the basis of a time schedule.

7.2.2 Manual

Selecting MANUAL the DHW requests are always met.

7.2.3 DHW BOOST (only with full electric)

In the electric configuration, there is a DHW BOOST function which, when activated, forces the system to heat the water in the storage tank so it is ready for use as quickly as possible.

This function can be personalised on the basis of the system and the user's specific needs.

In fact the storage tank setpoint temperature is equal to the value set for the BOOST SET-POINT parameter, but the BOOST ACTIVE TIME parameter can be set to define the maximum activation time of the DHW BOOST function.

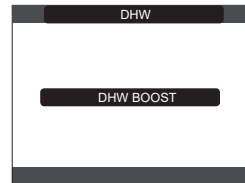

This function is only available if there is a DHW storage tank in the system.

When the BOOST function is enabled, the letter B will appear on the display; the B and the storage tank icon will flash when the function is being used.



The function is not active with the OFF status.

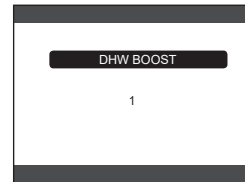

7.3 MAIN ZONE

Selecting this function allows you to set the main zone's status, by choosing one of the following options:

- if heating programming timing is not enabled:
 - ON
 - OFF
- if heating programming timing is enabled:
 - AUTO
 - MANUAL
 - OFF.

To select a different status, highlight it with the “up” and “down” keys, then press “ok”.

Once the selection has been validated, the display returns to the STATE screen.

Press “back” to return to the STATE screen without making any selection.

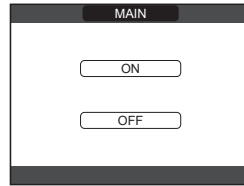

7.3.1 ON

If ON is selected, the zone requests are met.

7.3.2 AUTO

If AUTO is selected, the zone requests will be managed based on a time schedule.

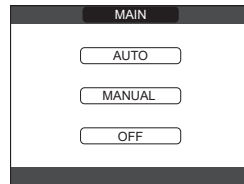

7.3.3 MANUAL

If MANUAL is selected, the zone requests will be managed based on the setpoint defined by the user.

7.3.4 OFF

If OFF is selected, the zone requests will not be met.

NOTE: if you want to deactivate the zone in HOT WATER ONLY or in HEATING AND HOT WATER, you must select the pre-set season (HOT WATER ONLY or HEATING AND HOT WATER in the BOILER menu) and set the zone concerned to OFF.

7.4 HEAT PUMP (if available)

Selecting HEAT PUMP, you can enable NIGHT-TIME REDUCTION. This parameter reduces the noise made by the heat pump, by limiting the maximum operating frequency of the compressor in the time band defined with the NIGHT MODE START TIME and NIGHT MODE STOP TIME parameters.

NIGHT MODE START TIME (IF ENABLE NIGHT REDUCT IS ACTIVE)

This parameter sets the starting time for the limiting of the heat pump compressor frequency when the night-time reduction function is enabled.

Range 00:00 - 23:59

Default 20.00

NIGHT MODE STOP TIME (IF ENABLE NIGHT REDUCT IS ACTIVE)

This parameter sets the finishing time for the limiting of the heat pump compressor frequency when the night-time reduction function is enabled.

Range 00:00 - 23:59

Default 9.00

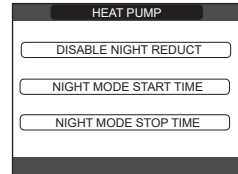
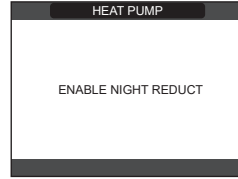

7.5 ANTILEGIO CUT OFF (only if awater tank is available)

The anti-legionella function can be interrupted in advance in these different ways:

- setting the boiler to OFF,
- selecting DHW in the STATE menu, and then ANTILEGIO CUT OFF

If the function is interrupted, it will be repeated at the same time the next day, even if weekly programming is active.

8. SET

The SET function is used to configure the set-points for HEATING, HOT WATER, COOLING (if heat pump configured), WATER TANK SETPOINT (if water tank configured) and PRE-HEATING.

In electric configuration, BOOST SETPOINT and BOOST ACTIVE TIME can also be set if the DHW BOOST function is active.

This is done by using the “up” and “down” ekeys to highlight the required item, then pressing “ok” to confirm.

Press “back” to return to the initial screen without making any selection.

8.1 HEATING

Press “up” and “down” to modify the heating setpoint, then press “ok” to confirm.

Press “back” to return to the SET screen without making any selection.

When an outdoor temperature sensor is installed, the outlet temperature is automatically selected by the system, which quickly adjusts the ambient temperature according to the variations in the outdoor temperature. If you want to change the temperature, raising it or lowering it with respect to that automatically calculated by the electronic board, it is possible to change the HEATING setpoint selecting the desired comfort level within the range (-5 to +5).

The user is then asked to confirm the setpoint setting: select CONFIRM or CANCEL with the “up” and “down” keys, then press “ok” to confirm.

Once the selection is confirmed, the display returns to the SET screen.

If the selection is cancelled or the “back” key is pressed, the display returns to the previous SET screen.

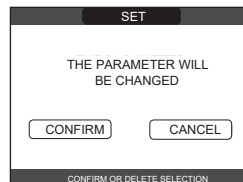
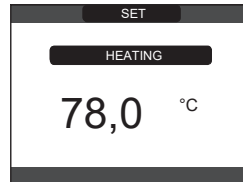
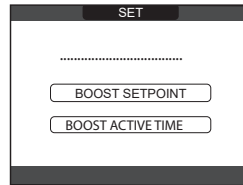
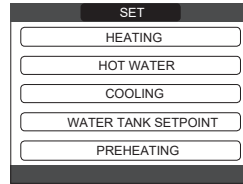

8.2 DHW



This parameter has different functions depending on the type of system available:

- with a combined boiler, the parameter refers to the temperature of the instantaneous DHW leaving the boiler.
- with a heating-only boiler connected to a DHW storage tank, the parameter refers to the temperature of the DHW in the storage tank.

Press “**up**” and “**down**” to modify the DHW setpoint, then press “**ok**” to confirm. Press “**back**” to return to the SET screen without making any selection.

You will then be asked to confirm the setpoint value: select **CONFIRM** or **CANCEL** with the “**up**” and “**down**” keys, then press “**ok**” to confirm.

Once the selection is confirmed, the display returns to the previous **SET** screen.

If the selection is cancelled or the “**back**” key is pressed, the display returns to the SET screen.

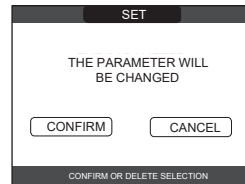
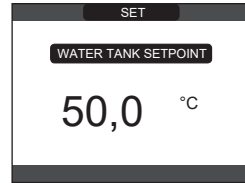
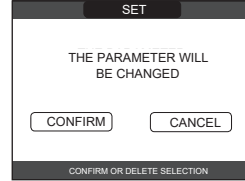
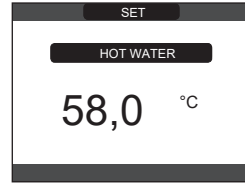

8.3 WATER TANK SETPOINT (domestic hot water from the water tank, if available)



This parameter is enabled if heat pump pre-heating is available on the DHW water tank.

Press “**up**” and “**down**” to modify the setpoint of the DHW kept in the water tank and heated by the heat pump, then press “**ok**” to confirm. Press “**back**” to return to the **SET** screen without making any selection.

You will then be asked to confirm the setpoint value: select **CONFIRM** or **CANCEL** with the “**up**” and “**down**” keys, then press “**ok**” to confirm.

Once the selection is confirmed, the display returns to the previous SET screen.

If the selection is cancelled or the “**back**” key is pressed, the display returns to the **SET** screen.

FOR SYSTEMS WITH A DHW MIXER VALVE

If the DHW temperature to the circuit needs to be adjusted, first of all check the mixer valve to see the position of the indicator on the brass body in relation to the graduated reference scale:

- 3 —————> 30°C
- 4 —————> 40°C
- 5 —————> 50°C

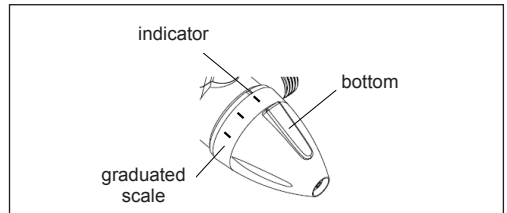

The mixer valve adjustment field is between 30°C and 56°C (full scale); to alter the setting, press the button on the knob and rotate the knob until the indicator is in line with the required value on the graduated scale.

NOTE: after completing this operation, check the DHW setpoint value on the boiler and on the storage tank are at least the same as the value set on the mixer valve..

8.4 PREHEATING (available with combined boiler)

This function keeps the water in the domestic hot water exchanger hot, to reduce standby times when a request is made. When the pre-heating function is enabled the symbol P comes on with a steady light at the top with respect to the hot water icon. During burner ignition following a pre-heating request, the letter P will begin to flash.

It is possible to access the PREHEATING function selecting SET on the main screen of the user interface. Setting PREHEATING = 1, the boiler's domestic hot water function is activated.

To deactivate the pre-heating function, set the parameter to PREHEATING = 0; the symbol P switches off.

The function is not active when the boiler is OFF.

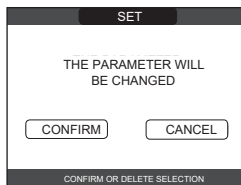
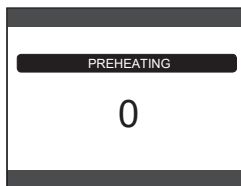

8.5 BIBERON FUNCTION

This function allows you to block the value set in the DHW setpoint, preventing anyone from being able to inadvertently modify it.

To activate the function, select BIBERON from the MENU and set the value to 1.



8.8 COOLING (available if a heat pump enabled for cooling is installed)

Press “up” and “down” to modify the cooling setpoint, then press “ok” to confirm.

Press “back” to return to the SET screen without making any selection.

When cooling temperature adjustment is activated, the delivery temperature value is automatically selected by the system, which quickly adjusts the ambient temperature according to the variations in the outdoor temperature.

If you want to change the temperature value from that automatically calculated by the electronic board, the COOLING setpoint can be modified within the range (-5 to +5) to obtain the required comfort level.

You will then be asked to confirm the setpoint value: select CONFIRM or CANCEL with the “up” and “down” keys, then press “ok” to confirm.

Once the selection is confirmed, the display returns to the previous SET screen.

If the selection is cancelled or the “back” key is pressed, the display returns to the SET screen.

NOTE: this parameter is available when the system contains a heat pump enabled for ambient cooling.

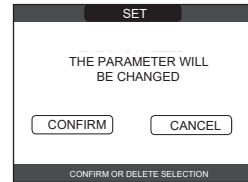
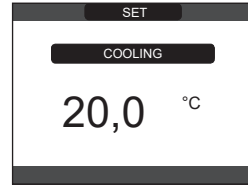

8.9 BOOST SETPOINT and BOOST ACTIVE TIME (in electric systems only)

By setting the BOOST SETPOINT parameter, the setpoint temperature of the storage tank will be equal to the value of the parameter. By setting the BOOST ACTIVE TIME parameter, you can define the maximum activation time of the DHW BOOST function.

	DEFAULT VALUE FACTORY SET	MINIMUM VALUE	MAXIMUM VALUE	ACCESS LEVEL NOTES
—SET				
—HEATING	80,5 (HT) - 45°C (LT)	MIN CH SET	MAX CH SET	USER
—DHW	0°C	-5°C	+5°C	USER, if EXTERNAL SENSOR connected and REQUEST TYPE TA
—COOLING	60,0°C	37,5°C	60°C	USER
	18°C	4°C	20°C	if you work at a fixed point
	0	-5	+5	if you work with climatic curves
—PREHEATING	0	0	2	USER (only instantaneous boiler)
—WATER TANK SETPOINT	60°C	37,5°C	60°C	USER (with water tank)
—BOOST SETPOINT (see par. 8)	60°C	50°C	80°C	USER (only full electric)
—BOOST ACTIVE TIME (see par. 8)	15min	1min	30min	USER (only full electric)

9. INFO

Press the INFO key on the user interface display to see a list of information items relating to system operation.

Switch from the visualisation of one parameter to the next or previous one using the “up” and “down” keys respectively.

ATTENTION - The displayed data cannot be modified.

INFO list

- SCREED HEATING HOURS
- CH SENSOR
- RETURN SENSOR
- DHW SENSOR
- HW TANK HIGH
- HW TANK LOW
- COLLECTOR TEMP
- EXHAUST SENSOR
- OUTDOOR TEMP PROBE
- FILTERED OUTDOOR TEMP
- FLOWMETER/DHW SETPOINT
- FAN SPEED
- ZONE 1 OUTLET
- ZONE 2 OUTLET
- EXHAUST SENSOR HOURS
- SET MAIN ZONE
- SET ZONE 1
- SET ZONE 2
- WATER PRESSURE
- CURVE (combustion - only with AKM boiler card)
- HP OUTLET
- HP RETURN
- HP OUTDOOR TEMP
- LOW PRESS TUBE REFR
- HIGH PRESS TUBE REFR
- CONDENSER REFR
- EXCHANGER REFR
- HP OPERATIVE MODE (HP control panel: MENU > OPERATION PARAMETER > OPERATION MODE)
- HP FREQUENCY
- HP COMPRESSOR TIME
- HP PUMP TIME
- HP FLOW SWITCH
- HP CAPACITY



Some info might not be available, depending on the system configuration.

- DHW BOOST
- EXCHANGE SERVICE
- DHW HOURS
- CH HOURS
- DHW MODULATION
- CH MODULATION
- CH SUPPLY SENSOR AVG
- DHW SUPPLY SENSOR AVG
- CH RETURN SENSOR AVG
- DHW RETURN SENSOR AVG
- GAS VALVE ON CYCLE
- IONO
- SYPHON FILL (HIGH EFFICIENCY)
- HP SETPOINT (type 0)
- INSTANTANEOUS HP CAPACITY (type 1)
- ENERGY CONSUMPTION INFO (type 1).

The “ok” key is not activated.

Use the “back” key to return to the initial screen.

Explanatory table of the references used in this manual

Descrip.		Heat pup type
Type 0	→	Hydronic Unit B HE Hydronic Unit LE B - Vega B
Type 1	→	HYDRO UNIT M - Vega M
Type 2	→	HYDRO UNIT P

10. MENU

The MENU function provides access to the SETTINGS and TIME SCHEDULE configuration (if POR=1).

This is done by using the “up” and “down” keys to highlight the required item, then pressing “ok” to confirm.

Press “back” to return to the initial screen without making any selection.

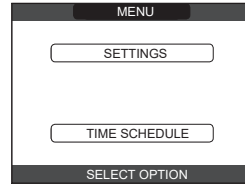

10.1 SETTINGS

Select this function to modify the following settings:

- TIME AND DATE
- DAYLIGHT SAVING TIME
- LANGUAGE
- BACKLIGHT.

Highlight the required setting using the “up” and “down” keys, then press “ok” to confirm.

Press “back” to return to the initial screen without making any selection.

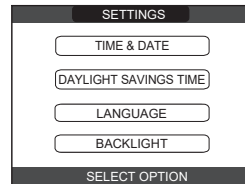

10.1.1 TIME AND DATE

Press “ok” to highlight HOURS, MINUTES, DAY, MONTH, YEAR in this order, then press “up” and “down” to alter the values as required.

Once the sequence has been terminated by pressing “ok”, the settings will be confirmed and the display will return to the initial screen.

Press “back” at any time to return the system to the SETTINGS screen without saving any changes.

Note: the device manages the change from Standard Time to Daylight Saving Time (and vice versa) automatically.

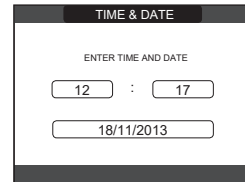

10.1.2 DAYLIGHT SAVING TIME

Select FUNCTION ACTIVE to enable the automatic management of the switch from Standard Time to Daylight Saving Time and vice versa.

10.1.3 LANGUAGE

Press “up” and “down” to select the required language. Press “ok” to confirm the selected language. The display will then return to the initial screen. Press “back” to return the system to the SETTINGS screen without changing the system language.



10.1.4 BACKLIGHT

Press “**up**” and “**down**” to select the display illumination time.

Press “**ok**” to confirm the selection. The display will then return to the initial screen.

Press “**back**” to return the system to the SETTINGS screen without saving the changes.

Once the set time has elapsed without any button being pressed, the fault warning screen will be displayed if the system is experiencing a fault, or else the backlighting will turn off and only the clock will be displayed. The screen will also display the flame icon if the burner is on and/or the heat pump icon if the heat pump is in function. Press any key to reactivate the backlighting and return to the initial screen.



10.2 TIME SCHEDULE

Selecting this function allows for the following time schedules to be modified:

- MAIN zone (if POR=1)
- ZONE 1 (if zone added and POR=1)
- ZONE 2 (if zone added and POR=1)
- DHW (with water tank)
- HP DHW (with heat pump present)

To access the required time schedule, select it with the “**up**” and “**down**” keys and then press to confirm “**ok**”.

Press “**back**” to return to the initial screen without making any selection.

NOTES:

- the MAIN, ZONE 1 or ZONE 2 parameter is available if time schedule is active for that zone (POR=1)
- the DHW parameter is available if there is heating-only boiler integration on the storage tank
- the HP DHW parameter is available if the system is fitted with a heat pump that heats the domestic hot water in the storage tank

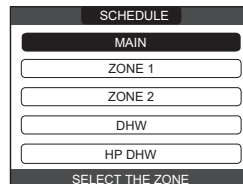

- for the HP DHW parameter, there are two time schedules: one for winter and the other for summer. Select the required season (HOT WATER ONLY or HEATING AND HOT WATER) from the STATE/BOILER menu, then program the HP DHW parameter.

WARNING: in HOT WATER ONLY, the parameter is factory set to keep time schedule active every day of the week from 05:00 to 08:00, to prevent continuous heat pump cycle reversals if the cooling function is active. If you want to alter this setting, contact After Sales Service.

For a detailed description of the time schedule, refer to the “TIME SCHEDULE” section.

11. TIME SCHEDULE

Select the required day, using the “up” and “down” keys. A table will be displayed indicating the day and the time slots already present. Press “ok” to access the programming for the selected day.

Press “back” to return to the initial screen without making any selection.

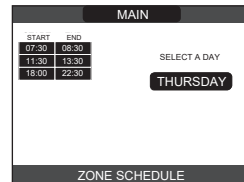

Once the selection has been made, the user can choose from the following options:

- ADD
- MODIFY
- DELETE
- COPY

11.1 ADD

This function adds a new time slot to the selected day.

Press “**ok**” to select the function, after highlighting it using the “**up**” and “**down**” keys (if necessary).

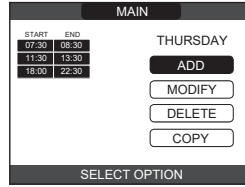

Press “**up**” and “**down**” to increase or decrease the start time by 30 minutes, then press “**ok**” to confirm.

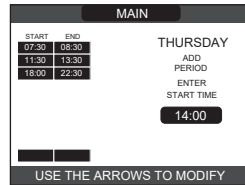

Press “**up**” and “**down**” to increase or decrease the end time by 30 minutes, then press “**ok**” to confirm.

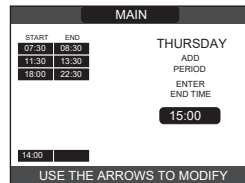

In order to confirm that the operation has been completed successfully, the display will show the table with the new time slot flashing.

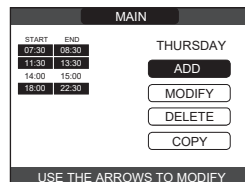

11.2 MODIFY

This function edits a time slot already present for the selected day.

Press **“ok”** to select the function, after highlighting it using the **“up”** and **“down”** keys (if necessary).

START	END
07:30	08:30
11:30	13:30
18:00	22:30

THURSDAY

ADD

MODIFY

DELETE

COPY

SELECT OPTION

Press **“up”** and **“down”** to select the required time band, then press **“ok”** to confirm.

START	END
07:30	08:30
11:30	13:30
18:00	22:30

THURSDAY

SELECT PERIOD TO MODIFY

07:30

USE THE ARROWS TO MODIFY

Press **“up”** and **“down”** to increase or decrease the start time by 30 minutes, then press **“ok”** to confirm.

START	END
07:30	08:30
11:30	13:30
18:00	22:30

THURSDAY

ENTER START TIME

11:30

USE THE ARROWS TO MODIFY

Press **“up”** and **“down”** to increase or decrease the end time by 30 minutes, then press **“ok”** to confirm.

START	END
07:30	08:30
11:30	13:30
18:00	22:30

THURSDAY

ENTER END TIME

14:00

USE THE ARROWS TO MODIFY

In order to confirm that the operation has been completed successfully, the display will show the table with the new time slot flashing.

You can now select a new time band to be modified, or press **“back”** to return to the previous TIME SCHEDULE screen.

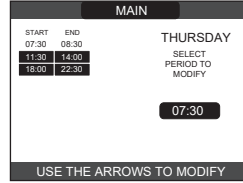

11.3 DELETE

This function deletes a time slot already present for the selected day.

Press **“ok”** to select the function, after highlighting it using the **“up”** and **“down”** keys (if necessary).

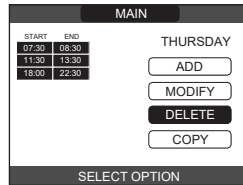

Press **“up”** and **“down”** to select the required time band, then press **“ok”** to confirm.

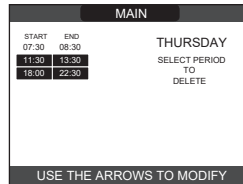

To confirm or cancel your selection, highlight the relative option and then press **“ok”** to confirm.

In order to confirm that the operation has been completed successfully, the display will show the table with the selected time slot flashing just before deleting it from the table.

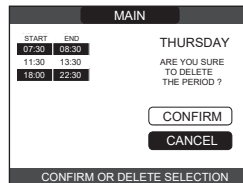

11.4 COPY

This function copies the time schedule for the selected day.

Press **“ok”** to select the function, after highlighting it using the **“up”** and **“down”** keys (if necessary).

MAIN

START	END
07:30	08:30
11:30	13:30
18:00	22:30

THURSDAY

ADD

MODIFY

DELETE

COPY

SELECT OPTION

Press **“up”** and **“down”** to select the day that you want to copy the time schedule onto, then press **“ok”** to confirm.

MAIN

SELECT DAYS ON WHICH YOU WANT TO COPY SCHEDULE OF THURSDAY

MON TUE WED **THU** FRI

SAT SUN

CONFIRM

USE THE ARROWS TO MODIFY

The day will be highlighted and others can be selected using the same procedure.

After making your selection, highlight CONFIRM and press **“ok”**.

MAIN

SELECT DAYS ON WHICH YOU WANT TO COPY SCHEDULE OF THURSDAY

MON TUE WED **THU** FRI

SAT SUN

CONFIRM

USE THE ARROWS TO MODIFY

In order to confirm that the operation has been completed successfully, the display will show the list of days to which the time schedule has been copied.

MAIN

SCHEDULE OF THURSDAY WILL BE COPIED ON THE DAYS: TUESDAY

USE THE ARROWS TO MODIFY

12. FAULTS

If any faults should occur, a screen will appear on the display indicating the relative error code and a brief alphanumeric description. Press **“back”** to return to the main screen, where the fault will be indicated by a new flashing icon:



You can return to the fault description screen by using the **“up”** and **“down”** keys to highlight the icon, and then pressing **“ok”**. The fault description screen is automatically displayed once the display illumination time has elapsed without any button being pressed.

Press **“up”** and **“down”** to see the description of any other faults.

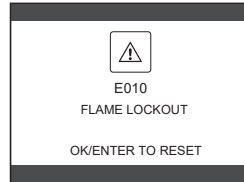
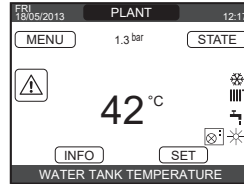

12.1 LIST OF BOILER FAULTS

For the list of boiler faults and possible solutions, refer to the boiler user manual.

12.2 LIST OF ZONE FAULTS

ERROR CODE	DESCRIPTION OF TYPE OF ALARM
E077	WATER THERMOSTAT - MAIN ZONE or ZONE 1 or ZONE 2
E081	FAULT ON AMBIENT PROBE, ZONE 1
E082	FAULT ON AMBIENT PROBE, MAIN ZONE or ZONE 2
E084	ZONE1 DELIVERY PROBE FAULT
E086	FAULT ON DELIVERY PROBE, MAIN ZONE or ZONE 2
--	COMMUNICATION LOST MAIN/ZONE1/ZONE2

12.3 LIST OF HEAT PUMP FAULTS (*)

ERROR CODE	DESCRIPTION OF TYPE OF ALARM
02, 04, 05, 06, ...	HEAT PUMP ALARM 02, 04, 05, 06, ...
--	HEAT PUMP COMMUNICATION LOST
--	BE17 COMMUNICATION LOST

12.4 LIST OF SOLAR FAULTS (IF PRESENT)

ERROR CODE	DESCRIPTION OF TYPE OF ALARM
E060	HIGH STORAGE TANK PROBE FAULT
E061	LOW STORAGE TANK PROBE FAULT
E062	SOLAR SYSTEM STORAGE TANK PROBE
--	SOLAR SYSTEM COMMUNICATION LOST
--	STORAGE TANK CONFIGURATION INCOMPLETE

(*) NOTE: for more detailed information on the reset methods and the meanings of the faults associated with the heat pump, refer to the "Faults" section in the relative "INSTALLATION, USE AND MAINTENANCE INSTRUCTIONS" document.

12.5 RESET FUNCTION

To reset boiler operation in the event of a fault, go to the fault description screen. If the lockout is of a non-volatile type that requires a reset procedure, this will be indicated and you can do it by pressing the “ok” key on the user interface.

At this point, the boiler or system will restart automatically if the correct operating conditions have been restored.

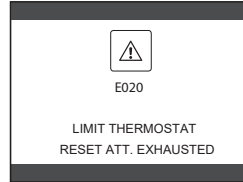
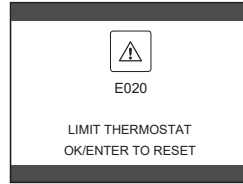

RESET BUTTON

Up to 5 consecutive resets can be made from the user interface, after which the RESET button on the boiler must be used (see adjacent figure) or the machine must be disconnected from the power supply so that the maximum number of attempts can be zero-set.



If the reset attempts do not reactivate the boiler, contact your local After Sales Service.

NOTE: if the fault is related to the heat pump, bear in mind that some of the heat pump alarms are automatically reset whereas others require the manual intervention of the After Sales Service (refer to the heat pump “Installation, use and maintenance” manual for more details).

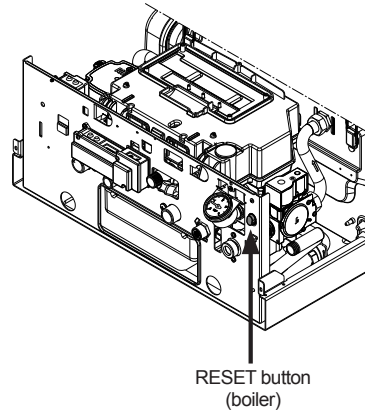

13. HOW TO USE...

Ambient regulator = machine interface + ambient temperature regulation and time schedule

In addition to the machine interface functions described above, the REC performs the functions of room temperature regulation and time schedule.

Chronothermostat = room temperature adjustment + time schedule of the associated zones

In this configuration the REC10MH performs the function of room regulation and time schedule of the associated zone.

In the MAIN screen you can select:

- MODE
- AMBIENT SET-POINT
- INFO (see "9. INFO")
- MENU

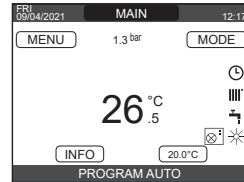

13.1 MODE

Unlike that which was indicated for the user interface function, in this case the mode refers to the zone's adjustment mode. The available modes are the following:

- **AUTO**: the ambient temperature is adjusted based on the weekly time schedule that has been set.
- **ECO**: similar to AUTO mode, but with the temperature set-point reduced by 3°C in HEATING AND HOT WATER mode, and increased by 3°C in HOT WATER ONLY mode (if COOLING is enabled).
- **HEAT OFF**: indicates that a heating request is never activated for that zone; a minimum ambient temperature of 8°C is guaranteed in HEATING AND HOT WATER mode, and a maximum temperature of 40°C is guaranteed in HOT WATER ONLY mode (if COOLING is enabled).

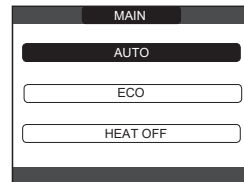

13.2 AMBIENT SETPOINT

By selecting the ambient set-point, the user can activate COMFORT adjustment mode. This mode consists of setting an ambient temperature set-point value for a time-limited interval. Once the temperature has been selected, the user is prompted to enter the duration of the interval in question. Once the set time has elapsed, the mode switches back to that which was previously set.

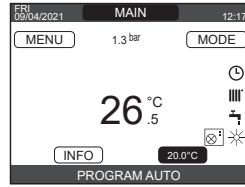

To activate COMFORT mode, highlight the temperature using the “up” and “down” keys. Once the selection has been confirmed by pressing “ok”, the temperature value will start to flash.

Press “up” and “down” to modify the temperature in steps of 0.5°C.

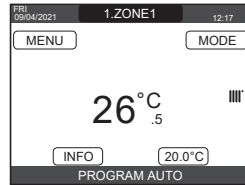

Once the selection has been confirmed, a new screen will appear, prompting the user to set COMFORT mode duration.

Make the modification using the “up” and “down” keys. The selected value can range from 30 minutes to 24 hours, with 30 minute intervals.



After confirming by pressing “ok”, a summary will be displayed indicating the temperature and duration of COMFORT mode.

The user will once again be prompted to confirm the selections made.



COMFORT mode temperature and duration programming can be abandoned at any time by pressing “back”.

13.3 MENU

The MENU function provides access to the configuration of SET BOILER, SETTINGS and TIME SCHEDULE.

This is done by using the “up” and “down” keys to highlight the required item, then pressing “ok” to confirm.

Press “back” to return to the initial screen without making any selection.

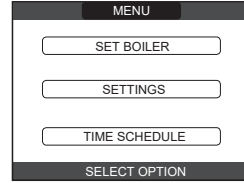

13.3.1 Set boiler (chronothermostat)

Press “up” and “down” to modify the delivery set-point, then press “ok” to confirm.

NOTE -If an outdoor temperature sensor is connected, the delivery set-point is automatically calculated by the machine for heating in HEATING AND HOT WATER mode, while it continues to be manually set by the user for cooling in HOT WATER ONLY mode.

Press “back” to return to the MENU screen without making any selection.

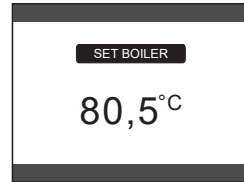

The user is then asked to confirm the setpoint setting: select **CONFIRM** or **CANCEL** with the “up” and “down” keys, then press “ok” to confirm.

Once the selection is confirmed, the display returns to the MENU screen.

If the selection is cancelled or the “back” key is pressed, the display returns to the previous MENU screen.

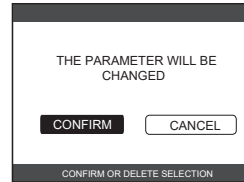

13.3.2 Settings

Select this function to modify the following settings:

- TIME AND DATE
- DAYLIGHT SAVING TIME
- LANGUAGE
- BACKLIGHT

To modify the settings, please refer to the following sections:

- “10.1 SETTINGS”
- “10.1.1 TIME AND DATE”
- “10.1.3 LANGUAGE”
- “10.1.4 BACKLIGHT”

NOTE: if the zone is controlled by an ambient probe, it is possible to make the same settings from the REC10MH MASTER in the screen of the concerned zone.

13.3.3 Time schedule (ambient regulator and chronothermostat)

From this menu it is possible to access the display and adjustment of the time schedule.

Up to 4 bands can be set for each day of the week, characterized by a start time and an end time.

In this operating mode, the time schedule also allows setting a **room temperature setpoint as described below**.

To add a time band, carry out the following operations:

select ADD and confirm with “ok”.

Press “up” and “down” to increase or decrease the start time by 30 minutes and confirm with “ok”.

Press “up” and “down” to increase or decrease the end time by 30 minutes and confirm with “ok”.

Press “up” and “down” to increase or decrease the setpoint value by 1°C and confirm with “ok”.

Continue with the programming of the other time bands.

For a detailed description of the other functions relating to time programming (EDIT - DELETE - COPY) refer to paragraph “11. TIME SCHEDULE”.

NOTE - Note how, in the presence of a zone regulated by REC10MH in chronothermostat configuration, it is no longer possible to set the relative time schedule on the REC10MH which performs the machine interface functions. The latter will be managed only by the corresponding REC10MH chronothermostat.

NOTE: if the zone is controlled by an ambient probe, it is possible to make the same settings from the REC10MH MASTER in the screen of the concerned zone.

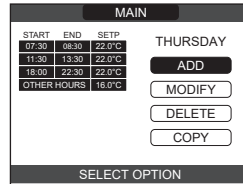

14. MULTI-ZONE MANAGEMENT

- If the system includes secondary zones not controlled by a REC10MH, a reference screen for each zone is enabled on the machine interface.
- The switch between this screen and the interface one is made by selecting the item at the top (the zone name or "SYSTEM") and pressing CONFIRM or CANCEL.
- This allows the user to cyclically scroll through the screens associated with all the zones, as well as the main interface screen.
- The information on the reference screen concerns the zone whose screen is associated. The meanings are the same as those already explained for the operating modes, apart from the fact that zone deactivation is indicated by a scrolling message at the bottom of the page rather than the word "OFF" above the heating icon (as is the case for the MAIN zone).

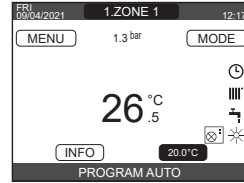

14.1 FAULTS

If the chronothermostat loses communication with the machine interface, a screen will appear indicating the error code and a brief alphanumeric description. Press **“back”** to return to the main screen, where the fault will be indicated by a new flashing icon:



You can return to the fault description screen by using the **“up”** You can return to the fault description screen by using the **“down”** keys to highlight the icon, and then pressing **“ok”**. The fault description screen is automatically displayed once the display illumination time has elapsed without any button being pressed.

Press the **“up”** and **“down”** keys to see the description of any other faults.

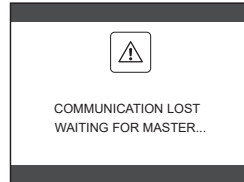
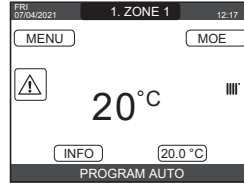

14.1.1 List of timed thermostat faults

Error code	Description
--	WAITING FOR MASTER...
--	COMMUNICATION LOST WAITING FOR MASTER...

Via Risorgimento, 23/A
23900 LECCO -Italy

Since the company is constantly improving its range of products, the appearance and dimensions, the technical data, the equipment and accessories can be subject to variation.